



The word "Megger" is a registered trademark

Megger[®]

SMRT36

Megger Relay Test System



- **Small, rugged, lightweight and powerful**
- **Operate with or without a computer**
- **Intuitive manual operation with Smart Touch View Interface**
- **High current, high power output (60 Amps/300 VA rms) per phase**
- **Convertible channels provides 6 currents**
- **Network interface provides IEC 61850 test capabilities**
- **Fully automated testing using AVTS Software**

DESCRIPTION

For size, weight, and features the SMRT36 is conceivably the smallest, lightest, highest output powered, complete three phase relay test system in the world today. The test system may be customized by adding the number of Voltage-Current, "VIGEN", modules needed for specific test applications. The SMRT36 has the "smart" combination of high compliance voltage and high current to test all electromechanical, solid-state and microprocessor-based overcurrent relays, including voltage controlled, voltage restraint and directional overcurrent.

The SMRT36 with three VIGEN Modules provides a complete three-phase test system for commissioning of three phase protection systems. With the voltage channels converted to currents, the same unit can provide 6-phase current. The SMRT36 VIGEN modules also provide high power in BOTH the voltage and current channels to test virtually all types of protective relays.



Model STVI with SMRT36

The SMRT36 test system has the ability to be manually controlled with Megger's new Smart Touch View Interface™ (STVI). The STVI, with its large, full color, high resolution, TFT LCD touch screen allows the user to perform manual, steady-state and dynamic testing quickly and easily using the manual test screen, as well as using built-in preset test routines for most popular relays.

The STVI eliminates the need for a computer when testing virtually all types of relays. Menu screens and touch screen function buttons are provided to quickly and easily select the desired test function. Tests results can be saved to the STVI for download to a memory stick to transfer or print test reports.

For full automatic testing the SMRT36 may be controlled by Megger Advanced Visual Test Software (AVTS). AVTS is a Microsoft® Windows® XP®/Vista™/7 compatible software program designed to manage all aspects of protective relay testing using the new Megger SMRT.

APPLICATIONS

Each current channel is rated for 30 Amps @ 200 VA continuous, up to 60 Amps @ 300 VA for short durations. It has a unique flat power curve from 4 to 30 Amps that insures maximum compliance voltage to load at all times. Three currents in parallel provide up to 180 Amps @ 900 VA for instantaneous tests. With a maximum compliance voltage of 50 Volts per phase, with just two channels in series provides 100 Volts of compliance voltage to test high impedance relays.

Each voltage channel can provide variable outputs of 0- 30/150/ 300 Volts at 150 VA of output power, and has a unique flat power curve from 30 to 150 Volts insuring maximum output power to the load at all times. With the voltage channel converted to current, a three channel unit can provide 6 currents for testing three phase current differential relays, including harmonic restraint transformer differential relays.

Using the Ethernet ports, the SMRT36 is literally a “plug-and-play” unit, where voltage and current outputs can be seamlessly synchronized with other SMRT units outputs for testing more complex test applications such as back-to-back tests, or 9 up to 12 phase current test applications.

FEATURES AND BENEFITS

Constant Power Output – New higher powered Voltage-Current amplifiers. The current amplifier delivers maximum compliance voltage to the load constantly during the test, and range changing is done automatically under load. This insures better test results, and saves time by not having to turn the outputs off to change ranges. Constant power output in many cases eliminates the need to parallel or series current channels together to test high burden relays.

High Output Current – Provides up to 30 Amps at 200 VA per phase continuous, or up to 60 Amperes at 300 VA with a 1.5 second duty cycle. The three current amplifiers can be paralleled to provide a maximum of 180 Amperes at 900 VA, for testing all instantaneous overcurrent relays.

New PowerV™ Voltage Amplifier High Power Output – The SMRT provides a new higher VA power output on the voltage channel at the lower critical test voltages (from 30 to 150 Volts). Customers who want to test a panel of relays at one time find it impossible using lower VA rated voltage.

Convertible Voltage Channels – With a 3 channel SMRT36 unit, convertible channels in conjunction with the three main current channels, provides 6 currents for testing three phase current differential relays. With all six currents in parallel the unit can provide a maximum single phase output of 225 Amperes for short durations.

High resolution and accuracy – Metered outputs provides extremely high accuracy needed for testing a wide variety of devices. With metered values, what you see is what you get.

Steady-State and Dynamic testing capability – The SMRT36 provides, either through manual control or computer control, both steady-state and dynamic testing of protective relays. This includes programmable waveforms with dc offset and harmonics.

Output current and voltage sine waves are generated digitally – Outputs do not vary with sudden changes in input voltage or frequency, which increases test accuracy and reduces testing time.

Digital binary inputs and outputs – The programmable binary inputs, and programmable outputs provide timing and logic operations in real-time with the output voltage and currents. Binary Inputs can be programmed, using Boolean logic, for more complex power system simulations. This provides a low cost, closed loop, power system simulator.

Circuit breaker simulator – Binary outputs provide programmable normally closed and normally open contacts to simulate circuit breaker operation for testing reclosing relays. Sequence of operation, timing, and lockout are easily tested.

Performs transient tests – Perform acceptance or troubleshooting tests by replaying digitally recorded faults or EMTP/ATP simulations in the IEEE- C37.111, COMTRADE Standard format.

Perform End-to-End tests – Using AVTS software and a portable GPS satellite receiver, the SMRT performs satellite-synchronized end-to-end dynamic multi-state or playback transient COMTRADE files either for commissioning or troubleshooting tests.

Wide-ranging output frequency – The output frequency of the current and voltage channels can be set for any frequency from dc to 1 kHz. Popular test frequencies such as 16.66, 25, 33, 50, 60, 100, 120, 125, 150, 180, 250, 300 and 400 Hz are easily set and controlled. Multi-purpose test system saves time and money.

USB 2.0 interface port – The USB port provides a PC interface for automated control of the SMRT unit. Also provides secure isolation when testing IEC 61850 devices (for customers who require secure isolation from their IEC 61850 substation bus).

Three Ethernet ports – PC/OUT Ethernet Port is the primary PC connection port. The IN/IEC61850 Ethernet Port provides interface to multiple SMRT units, and may be used to connect to the IEC 61850 substation bus. The OUT Ethernet Port is primarily used to interconnect multiple SMRT units together for synchronous multi-unit operation. The STVI PoE (Power over Ethernet) port and is used to connect to the STVI.

Bluetooth – Optional Bluetooth provides more flexibility. A wireless interface between the PC and SMRT, in conjunction with the SMRT IEC 61850 Ethernet port, provides the isolation required for a secure substation access interface between the SMRT and the IEC 61850 substation network.

Universal input voltage – Operation from 90 to 264 Vac, 50/60 Hz, the SMRT can use virtually any standard source in the world.

Immediate error indication – Audible and visual alarms indicate when amplitude or waveforms of the outputs are in error.

Modular design – Output modules plug-in and out easily for system re-configuration and maintenance.

SMRT36 RELAY TESTER

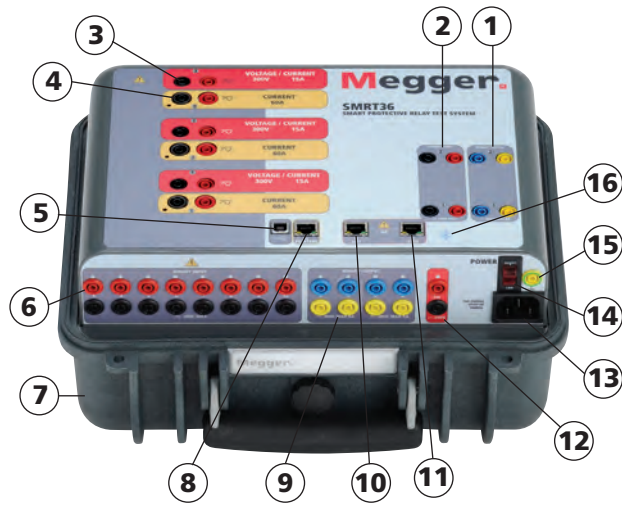

APPLICATIONS SELECTION GUIDE

1. **Binary Outputs 1 and 2:** Rated for 300 V at 8 Amps.
2. **Binary Inputs 1 and 2:** Rated 5 to 300 V AC/DC
3. **Voltage Outputs:** Up to 3 channels 300 V at 150 VA, convertible to currents 15 A at 120 VA per phase.
4. **Current Outputs:** Up to 3 channels 60 Amps at 300 VA per phase. Up 180 Amps at 900 VA single phase.
5. **USB 2.0 Interface:** Communication and control port.
6. **Additional Binary Inputs:** Provides 8 additional monitor circuits.
7. **Rugged Case:** Fiberglass reinforced plastic.
8. **PC/OUT:** Ethernet Port is the primary PC connection port. Ethernet Port used to chain multiple SMRT units together for synchronous multi-unit operation.
9. **Additional Binary Outputs:** Adds 4 outputs. Binary Outputs 3 and 4 are rated for 300 V AC/DC, 8 amperes. Binary Outputs 5 and 6 are high speed and have an AC/DC voltage rating of 400 volts peak, 1 ampere.
10. **IN/61850:** This port may also be used for connecting to the IEC 61850 substation bus for testing IEC 61850 devices.
11. **STVI:** Ethernet Port is a PoE (Power over Ethernet) port and is used to connect to the STVI for manual control.
12. **Battery Simulator:** Variable 5 to 250 Volts DC output at 100 Watts (4 amperes maximum).
13. **Incoming Power/Line Cord Socket:** 100 to 240 V, 50/60 Hz.
14. **POWER ON/OFF Switch:** Illuminates when power is on.
15. **Protective Earth Ground Jack.**
16. **Bluetooth:** Bluetooth® provides wireless control.

APPLICATIONS SELECTION GUIDE

Protective Relays by IEEE Device #	SMRT36 Single Channel	SMRT36 Two Channels	SMRT36 Three Channels	
2	Time Delay	✓	✓	✓
21	Distance Single Phase	✓	✓	✓
21	Distance Three Phase Open Delta		✓	✓
21	Distance Three Phase wye			✓
24	Volts/Hz	✓	✓	✓
25	Synchronizing		✓	✓
27/59	Under/Over Voltage	✓	✓	✓
32	Directional Power Single Phase	✓	✓	✓
32	Directional Power Three Phase (Open Delta)		(✓)	✓
37/76	DC Under/Over Voltage/Current	✓	✓	✓
40	Loss of Field	✓	✓	✓
46	Phase Balance Current	✓	✓	✓
46N	Negative Sequence Overcurrent	✓	✓	✓
47	Phase Sequence Voltage (Open Delta)		(✓)	✓
50	Instantaneous Overcurrent	Up to 75 Amps	Up to 150 Amps	Up to 225 Amps
51	Time Delay Overcurrent	Up to 35 Amps	Up to 70 Amps	Up to 105 Amps
55	Power Factor	✓	✓	✓
60	Voltage/Current Balance (Open Delta)	Single Phase	(✓)	✓
67	Directional Overcurrent	✓	✓	✓
67N	Ground Directional Overcurrent	✓	✓	✓
78	Out of Step	✓	✓	✓
79	Reclosing	✓	✓	✓
81	Frequency	✓	✓	✓
85	Carrier or Pilot Wire	✓	✓	✓
87	Differential	✓	✓	✓
91	Voltage Directional (Open Delta)		(✓)	✓
92	Voltage and Power Directional (Open Delta)		(✓)	✓
94	Tripping	✓	✓	✓

SPECIFICATIONS¹

Input Power

100 to 240 Volts (± 10%) AC, 1Ø, 50/60 Hz, 1800 VA

Outputs

All outputs are independent from sudden changes in mains voltage and frequency, and are regulated so changes in load impedance do not affect the output. All amplifier outputs are isolated or floating. The SMRT units can be ordered with the amplifier common returns tied to chassis ground as an option.

Output Current Sources

The SMRT36 with three VIGEN modules can provide up to six current sources; three high current/high power, and three convertible channels providing lower current/high power. The per channel output current and power ratings are specified in AC rms values and peak power ratings.

Output Current	Power	Max V/Duty Cycle
1 Ampere	15 VA	15.0 Vrms Continuous
4 Amperes	200 VA (282 peak)	50.0 Vrms Continuous
15 Amperes	200 VA (282 peak)	13.4 Vrms Continuous
30 Amperes	200 VA (282 peak)	6.67 Vrms Continuous
60 Amperes	300 VA (424 peak)	5.00 Vrms 90 Cycles
DC	200 Watts	

With three currents in parallel:

Output Current	Power	Max V/Duty Cycle
12 Amperes	600 VA (848 peak)	50.0 Vrms Continuous
45 Amperes	600 VA (848 peak)	13.4 Vrms Continuous
90 Amperes	600 VA (848 peak)	6.67 Vrms Continuous
180 Amperes	900 VA (1272 peak)	5.00 Vrms 90 Cycles

With two currents in series:

The compliance voltage doubles to provide 4.0 Amperes at 100 Volts rms.

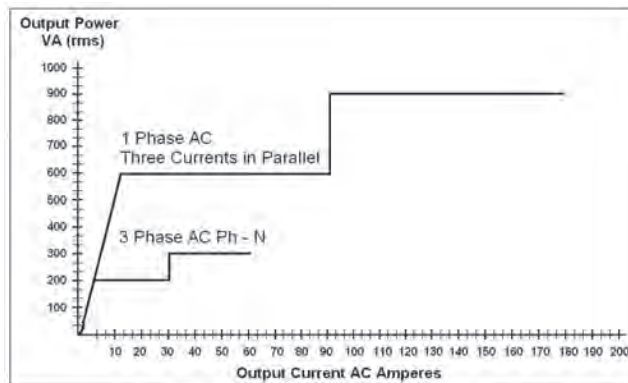

Current Amplifier Output Power Curve

Current Amplifier - Extended Power Range

The SMRT current amplifier provides a unique flat power curve from 4 to 30 Amperes per phase to permit testing of electromechanical high impedance relays, and other high burden applications, with an extended operating range up to 60 Amperes at 300 VA rms.

AC Voltage Output

Outputs are rated with the following Ranges:

Output Volts	Power	Max I
30 Volts	150 VA	5 Amps
150 Volts	150 VA	Variable ²
300 Volts	150 VA	0.5 Amps
DC	150 Watts	

Duty Cycle: Continuous

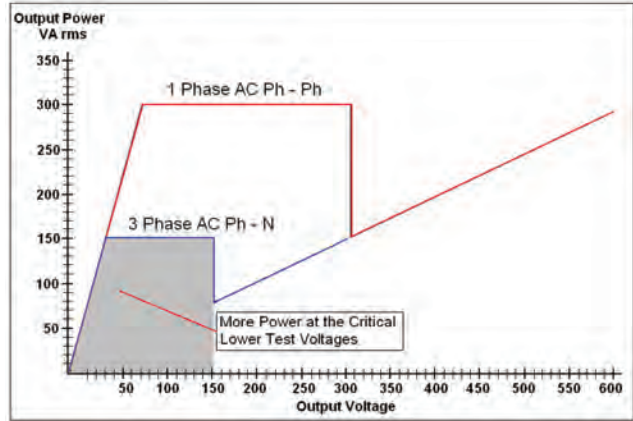

"PowerV" Voltage Amplifier Output Power Curves

"PowerV"™ Voltage Amplifier - Extended Power Range

The SMRT voltage amplifier provides a flat power curve from 30 to 150 Volts in the 150V range to permit testing of high current applications such as panel testing.

Voltage Amplifier in Current Mode:

The voltage amplifier is convertible to a current source with the following output capability. Output power ratings are specified in rms values and peak power ratings.

Output Current	Power	Max V	Duty Cycle
5 Amperes	150 VA (212 peak)	30.0 Vrms	Continuous
15 Amperes	120 VA	8.0 Vrms	90 Cycles

Phase Angle

Ranges: 0.00 to 359.99 degrees, Counter Clock Wise, or Clock Wise rotation, or 0.00 to ±180.00 degrees

Accuracy: ±0.02° typical, ±0.25° max at 50/60 Hz

Frequency

The output modules provide a variable frequency output with the following ranges and accuracy.

Ranges

DC

0.001 to 1000.000 Hz

Output amplifiers can provide transient signals with a range of DC to 10 kHz for transient playback using COMTRADE files.

Resolution*: .0001/.001 Hz

Frequency Accuracy:

2.5 ppm typical

25 ppm 0° to 50° C, at 50/60 Hz Maximum

Total Harmonic Distortion

Less than 0.1% typical, 2% maximum at 50/60 Hz

¹ Megger reserves the right to change product specifications at any time.

² PowerV™ voltage amplifier output current varies depending on the voltage setting on the 150 Volt range, see curve.

Timer

The Timer-Monitor Input is designed to monitor and time-tag inputs, like a sequence of events recorder. In addition, the binary input controls enable the user to perform logic AND/OR functions, and conditionally control the binary output relay to simulate circuit breaker, trip, reclose and carrier control operation in real-time. The Timer function displays in Seconds or Cycles, with the following range and resolution:

Seconds: 0.0001 to 99999.9

(Auto Ranging)

Cycles: 0.01 to 99999.9

(Auto Ranging)

Accuracy: $\pm 0.001\%$ of reading, typical. ± 2 least significant digit, $\pm 0.005\%$ of reading from 0 to 50° C maximum

Binary Input – Start/Stop/Monitor Gate

To monitor operation of relay contacts or trip SCR, continuity light is provided for the input gate. Upon sensing continuity the lamp will glow. In addition to serving as wet/dry contacts the Binary Inputs may be programmed to trigger binary output sequence(s).

Input Rating: up to 300 V AC/DC

Binary Output Relays

SMRT36 has independent, galvanically isolated, output relay contacts to accurately simulate relay or power system inputs to completely test relays removed from the power system. The binary output simulates normally open / normally closed contacts for testing breaker failure schemes. The binary output can be configured to change state based on binary input logic.

High Current Output Relays: The first two VIGEN Modules have 1 each and the P option add 2 more.

AC Rating: 400 V max., I_{max}: 8 amps, 2000 VA max.

DC Rating: 300 V max., I_{max}: 8 amps, 80 W

Response Time: <10ms

High Speed Output Relays: SMRT36 P Option adds 2

AC/DC Rating: 400 V peak, I_{max}: 1 amp

Response Time: <1ms typical

Battery Simulator

The SMRT36 with the P (Plus) option includes a battery simulator with a variable DC output voltage ranging from 5 to 250 Volts at 100 Watts, 4 Amps max, providing capability to power up relays with redundant power supplies. Voltage output is controlled via the Smart Touch-View Interface, or through AVTS software. The SMRT36 with the N option does not include a battery simulator.

Waveform Generation

Each output channel can generate a variety of output waveforms such as: DC; sine wave; sine wave with percent harmonics at various phase angles; half waves; square waves with variable duty cycles; exponential decays; periodic transient waveforms from digital fault recorders, relays with waveform recording capability or EMTP/ATP programs, which conform to the IEEE C37.111 COMTRADE standard format.

Metering

Measured output quantities such as AC Amperes, AC Volts, DC Volts or DC Amperes, and Time may be simultaneously displayed on the large, color TFT LCD touch screen. The AC and DC outputs display the approximate voltage/current output prior to initiation of the outputs.

AC Voltage Amplitude

Accuracy: $\pm 0.05\%$ reading + 0.02 % range typical, $\pm 0.15\%$ reading + 0.05 % range maximum

Resolution: .01

Measurements: AC RMS

Ranges: 30, 150, 300V

AC Current Amplitude

Accuracy: $\pm 0.05\%$ reading + 0.02 % range typical, $\pm 0.15\%$ reading + 0.05 % range maximum

Resolution: .001/.01

Measurements: AC RMS

Ranges: 30, 60A

DC Voltage Amplitude

Accuracy: 0.1% range typical, 0.25% range maximum

Resolution: .01

Measurements: RMS

Ranges: 30, 150, 300V

DC Current Amplitude

Accuracy: $\pm 0.05\%$ reading + 0.02 % range typical, $\pm 0.15\%$ reading + 0.05 % range maximum

Resolution: .001/.01

Measurements: RMS

Ranges: 30A

Convertible Source in AC Current Mode

Accuracy: $\pm 0.05\%$ reading + 0.02 % range typical, $\pm 0.15\%$ reading + 0.05 % range or ± 12.5 mA whichever is greater

Resolution: .001

Measurements: AC RMS

Range: 5, 15A

Environmental

Operating Temperature: 32 to 122° F (0 to 50° C)

Storage Temperature: -13 to 158° F (-25 to 70° C)

Relative Humidity: 5 - 90% RH, Non-condensing

Unit Enclosure

The SMRT unit comes housed in a rugged, virtually indestructible, lightweight and ergonomic enclosure. It features a large oversized rubber cushioned handle, and removable lid for use in tight spaces.

Dimensions

With the lid on:

14.2 W x 7.6 H x 12.0 D in.

(360 W x 194 H x 305 D mm)

With the lid off:

14.2 W x 7.2 H x 12.0 D in.

(360 W x 180 H x 305 D mm)

IEC Enclosure Rating: IP30

Weight

With the transit lid on: 27.9 lb. (12.55 kg)

With the transit lid off: 25.8 lb. (11.6 kg)

Conformance Standards

Safety: EN 61010-1

Shock: MIL-PRF-28800F (30g/11ms half-sine)

Vibration: MIL-RFP-28800F (5-500Hz, 2.05 g rms)

Transit Drop: MIL-RFP-28800F (10 drops, 46 cm)

Electromagnetic Compatibility

Emissions: EN 61326-2-1, EN 61000-3-2/3,

FCC Subpart B of Part 15 Class A

Immunity: EN 61000-4-2/3/4/5/6/8/11

Protection

Voltage outputs are protected from short circuits and thermally protected against prolonged overloads. Current outputs are protected against open circuits and thermally protected against prolonged overloads.

Communication Interfaces

Ethernet (2)

USB 2.0

Bluetooth (optional)

SOFTWARE**AVTS – STVI Basic**

Every unit comes with **AVTS Basic** software and the PC version of the **STVI Basic** software packages. AVTS Basic version includes Online Vector control (for single and multi-state timing tests), Online Ramp control (for automatic ramping of voltage, current, phase angles or frequency) and Online Click-On-Fault (for dynamic tests of impedance relays). Test results may be exported directly to Microsoft Word. AVTS software includes a database for saving test results, which can also provide the necessary information needed for system reliability audits. See **AVTS** bulletin for more information.

The PC version of the STVI software includes the ability to bring all STVI test data (from other STVI units) into file folders for retrieval, review and printing whenever needed. See **STVI** bulletin for more information.

AVTS Advanced

The AVTS Advanced version includes all the feature in AVTS Basic plus the powerful Test Editor, Dynamic Control (includes dynamic end-to-end testing capability, and waveform recording capability), ASPEN OneLiner™ or Electrocon CAPE™ SS1 File Converter for dynamic testing, and easy to use programming Tools for creating and editing test modules. See **AVTS** bulletin for more information.

AVTS Professional

The AVTS Professional version includes all of the features of the Basic and Advanced versions plus some other powerful test tools and features. It includes the DFR Waveform Viewer, One-Touch™ Test for fully automatic tests, Modbus communication test capability, and Waveform Digitizer to digitize scanned waveforms of electromechanical over current time curves. See **AVTS** bulletin for more information.

IEC 61850 GOOSE

The SMRT with the GOOSE enabled, in conjunction with the Megger GOOSE Configurator (MGC) software, can be used in the testing or commissioning of IEC 61850 compliant devices. See **AVTS** bulletin for more information.

ORDERING INFORMATION

STYLE NUMBER IDENTIFICATION

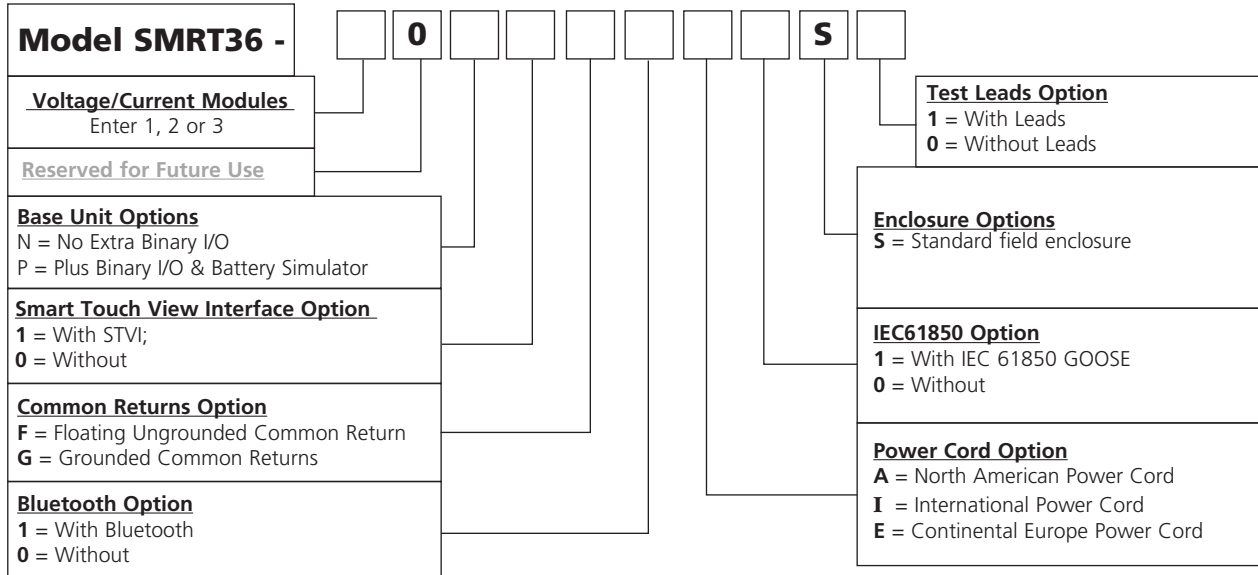

DESCRIPTION OF SOFTWARE OPTIONS

Included Software	Part Number
AVTS Basic with STVI Application CD	81302
AVTS Basic with IEC 61850 Megger GOOSE Configurator, and STVI Application CD	1002-103
Software Options	
AVTS Advanced with STVI Application CD	81570
AVTS Advanced Test with IEC 61850 Megger GOOSE Configurator, and STVI Application CD	1001-106
AVTS Professional with STVI Application CD	81571
AVTS Professional Test with IEC 61850 Megger GOOSE Configurator, and STVI Application CD	1002-102

DESCRIPTIONS OF HARDWARE OPTIONS

Voltage/Current Module: The SMRT36 unit can have up to a total of 3 voltage/current modules. Enter the number of desired Voltage / Current modules **1, 2 or 3**.

Future: 0, Reserved for future use.

Base Unit Options: The first two channels provide **1** binary input and **1** binary output each. Enter **N** for No extra binary I/O or battery simulator. For the user who requires the extra binary inputs, outputs and/or the battery simulator enter **P** for Plus option.

Smart Touch View Interface Option: Enter the number **1** for the unit to come with the STVI, or enter the number **0** for without.

Common Returns Option: Enter **F** for floating returns and **G** for grounded common returns. The floating returns option provides independent, isolated return terminals for each output channel. The second option is **G** for grounded common returns, where return terminals are interconnected internally and connected to chassis ground.

Power Cord Option: Customers can choose which type of power cord they want the unit to come with.

- **A Option** – NEMA 5-15 to IEC60320 C13 connectors, UL & CSA approved for countries with NEMA outlets.

- **I Option** - International color coded wires (light blue, brown and green with yellow stripe) insulation jacket stripped ready for male connector with IEC 60320 C13 connector. CE marked.
- **E Option** - CEE 7/7 “Schuko” plug to IEC 60320 C13 connector is CE marked.

Bluetooth Option: For customers who wish to have a wireless control of the SMRT unit, enter the number **1** for the unit to come with the Bluetooth option installed. Enter **0** for without.

IEC 61850 Option: The SMRT36 in conjunction with the Megger GOOSE Configurator (MGC) software can be used in the testing or commissioning of IEC 61850 compliant devices. In order for the SMRT36 to be able to subscribe as well as publish GOOSE messages, the IEC 61850 feature needs to be enabled. Enter the number **1** for the unit to come with the IEC 61850 option enabled. Enter **0** for the unit without IEC 61850 enabled.

Enclosure Option: **S** for Standard, rugged, field type enclosure.

Test Leads Option: Enter the number **1** for the unit to come with Test Leads. Enter **0** for the unit without Test Leads.

Test Leads and Accessories

All units come with a power cord (see Power Cord option), and Ethernet communication cable, and instruction manual CD. All other accessories varies depending on the options selected, see Table of Accessories.







DESCRIPTION

Included Standard Accessories	Part Number
Power Cord - Depending on the style number, the unit will come with one of the following,	
Line cord, North American	620000
Line cord, Continental Europe with CEE 7/7 Schuko Plug	50425
Line cord, International color coded wire	15065
Ethernet crossover cable for interconnection to PC, 210cm (7 ft.) long (Qty. 1 ea)	620094
Instruction manual CD	80989

Table of Accessories

Accessories are supplied with the selection of the Test Leads Option, and/or the Binary Input / Output / Battery Simulator Option, and/or the STVI Option. With the Test Leads Option the

number and type of leads varies depending on the number of channels ordered. If desired, Test Leads and Accessories can be ordered individually, see description and part numbers below.

	Optional Accessories Descriptions	STVI, or Binary I/O Bat SIM, or Test Leads Options	One (1) Voltage Current Module	Two (2) Voltage Current Modules	Three (3) Voltage Current Modules	Binary I/O, Battery Simulator Option
	Accessory Carry Case: Use to carry power cord, Ethernet cable, Optional STVI and test leads.	Qty. 1 ea. Part No. 2001-487				
	Sleeved Pair of Test Leads: Keeps the test leads in pairs and from getting entangled. Sleeved Test Leads, one red, one black, 200 cm (78.7") long, 600 V, 32 Amperes CAT II.		Qty. 3 pr. Part No. 2001-394	Qty. 6 pr. Part No. 2001-394	Qty. 2 pr. Part No. 2001-394	Qty. 3 pr. Part No. 2001-394
	Cable/Spade Lug Adapter (Small): Small lug fit most new relay small terminal blocks. Lug adapter, red, 4.1 mm, use with test leads up to 1000 V/ 20 Amps CAT II.		Qty. 3 ea. Part No. 684004	Qty. 6 ea. Part No. 684004	Qty. 12ea. Part No. 684004	Qty. 3 ea. Part No. 684004
	Lug adapter, black, 4.1 mm, use with test leads up to 1000 V/ 20 Amps CAT II.		Qty. 3 ea. Part Number 684005	Qty. 6 ea. Part Number 684005	Qty. 12ea. Part Number 684005	Qty. 3 ea. Part Number 684005
	Jumper Lead: Used to common returns together on units with floating ground returns, or parallel of current channels. Jumper lead, black, 12.5 cm (5") long, use with voltage / current outputs, 600 V, 32 Amps CAT II.			Qty. 2 ea. Part Number 2001-573	Qty. 4 ea. Part Number 2001-573	
	Sleeved Combination Voltage Test Leads: Keeps the test leads from getting entangled. Three common leads connect to the test set, which are interconnected down to one black common to connect to the relay under test. Sleeved Three Phase Test Leads, three red and black, 200 cm (78.7") long, 600 V, 32 Amperes CAT II.				Qty. 1 ea. Part Number 2001-395	
	Sleeved Combination Current Test Leads: Keeps the test leads from getting entangled. Three pairs of leads connect to the test set, with three pairs to connect to the relay under test. Sleeved Three Phase Test Leads, three red and black, 200 cm (78.7") long, 600 V, 32 Amperes CAT II.				Qty. 1 ea. Part Number 2001-396	

Note that the sleeved combination leads only come with the three module configuration.

Descriptions of Software

Included Software – Every unit comes with AVTS Basic and the PC version of the STVI Basic Test software packages

AVTS Basic with STVI Application Software (PC Version)

Part No.: 81302

AVTS Basic includes Online Vector, Online Ramp and Online Click-On-Fault controls, with the ability to import, save and execute relay specific test modules. The online tools of Vector and Ramp provide automatic pickup, or dropout tests as well as timing and multi-state dynamic tests. The Online Click-On-Fault tool is used to automatically determine the reach characteristics of single or multi-zone Distance relays using shot for single point tests, or Ramp, Pulse Ramp, or Binary Search tools along user defined search lines. Includes enhanced Relay Test Wizards for; Overcurrent, Differential, Voltage, Frequency and Distance relays.

The powerful STVI screens can be run directly from a PC providing both manual and automatic test capabilities. Intuitive menu screens and buttons are provided to quickly and easily select the desired test function. The Manual Test Screen power-up preset default values maybe automatically set from the user defined configuration screen. The user can select from a variety of test options including manual control using the cursor up down arrows or use the mouse control wheel to vary outputs. In addition a dynamic sequence test includes trip and reclose up to 9 operations. An automatic ramp, pulse ramp, or pulse ramp binary search is built in to determine pickup or drop out of relay contacts, or perform relay specific timing tests using the Timing Test Screen. A vector graph indicates the relative phase angles of all of the outputs. The user may select to have all output amplitudes metered to provide real time verification of all of the selected outputs, or have setting values displayed. The PC version of the STVI software includes the ability to bring all STVI test data (from other STVI units) into file folders for retrieval and review whenever needed. Each copy of the PC version of the STVI software is licensed for running on one PC. Additional run keys can be purchased seperately.

Additional Software Options

AVTS Advanced with STVI Application

Part No.: 81570

AVTS Advanced includes all of the features of AVTS Basic in addition to the powerful Test Editor and test editor tools, which includes the Dynamic Control (with dynamic end-to-end test capability, and Recorder features) for developing sequential tests for virtually any function or measuring element within digital relays. In addition, it also includes SS1 File Converter for ASPEN and CAPE dynamic test files, End-to-End DFR Playback test macros and basic programming Tools for creating and editing test modules. Test files created in Advanced Test can be used with AVTS Basic.

AVTS Professional with STVI Application

Part No.: 81571

Professional Test includes all of the features of AVTS Advanced Test version plus the following additional specialized test tools. The DFR Waveform Viewer and Playback tools are used for viewing and analyzing IEEE C37.111 COMTRADE Standard files from digital fault recorders and microprocessor based relays. The DFR Waveform Viewer includes tools to recreate the analog and digital channels for playback into protective relays for troubleshooting or evaluation. It includes the capability to extend the pre-fault data as well as start the timer associated with the event to time relay operation. These playback test files can also be used in end-to-end tests to recreate the transient event and evaluate the protection scheme. Test files created in Professional can be used with Advanced Test and Basic. Also included is the One-Touch Test Editor Control Tool for fully automatic testing of microprocessor based relays using VB script files or Modbus communications to automatically download relay settings, and automatically test all the measuring elements within the relay based upon those settings. The Waveform Digitizer feature is also included in the Professional Test version of AVTS. It provides tools to create digital time curves for virtually any electromechanical relay time curve (that do not fit a time curve algorithm). It can even be used for digitizing scanned waveforms from a light-beam chart recorder.

IEC 61850 Megger GOOSE Configurator Software

The Megger GOOSE Configurator (MGC) provides easy to use tools for testing relays and substations using the IEC 61850 protocol. It is an optional software tool available with Basic, Advanced or Professional versions of AVTS Software; see Descriptions of Software Options above. The configurator provides relay test engineers and technicians the capability to import parameters from configuration files in the Substation Configuration Language (SCL) format, and/or capture GOOSE messages directly from the substation bus. All imported GOOSE messages will be unconfirmed messages. Only captured messages are confirmed messages due to the Capture feature of the MGC. Use the MGC Merge feature to compare imported SCL and captured GOOSE messages to verify all GOOSE messages needed to perform tests. Use them to configure the SMRT to subscribe to preselected GOOSE messages by assigning the data attributes to the appropriate binary inputs of the SMRT. Use the configurator to assign the appropriate binary outputs of the SMRT to publish GOOSE messages simulating circuit breaker status. After the appropriate assignments of binary inputs and outputs have been made, the test file can be saved for reuse. This provides both manual and automatic testing of the relay using either the STVI or AVTS software. Use standard test modules in AVTS to perform automatic tests. Use the Dynamic Control in AVTS Advanced or Professional to perform high speed trip and reclose tests, or use to perform interoperability high-speed shared I/O tests between multiple IED's. The MGC provides mappings of Boolean and Bit Strings and/or simulation of STRuct, Integer/Unsigned, Float and UTC datasets.

Deluxe Test Leads and Accessories Kit Part No.: 1001-619

The Test Leads and Test Lead Accessories are an option. Test leads and accessories can be ordered with the unit, or later as a kit. The Deluxe Test Leads and Accessories Kit includes sleeved pairs of leads for use with the extra binary inputs/outputs/battery simulator option, as well as the three phase sleeved combination leads for voltage and current channels. The following test leads and test lead accessories are included in the Deluxe Test Leads and Accessories Kit in quantities shown.

Description	Part No.
Sleeved Combination Voltage Test Leads: Keeps the test leads from getting entangled. Sleeved Three Phase Test Leads, three red and black, 200 cm (78.7") long, 600 V, 32 Amperes CAT II (Qty. 1 ea)	2001-395
Sleeved Combination Current Test Leads: Keeps the test leads from getting entangled. Sleeved Three Phase Test Leads, three red and black, 200 cm (78.7") long, 600 V, 32 Amperes CAT II (Qty. 1 ea)	2001-396
Sleeved Pair Test Leads, one red, one black, 200 cm (78.7") long, 600 V, 32 Amperes CAT II (Qty. 5 pair)	2001-394
Jumper lead, black, 12.5 cm (5") long, use with voltage / current outputs, 600 V, 32 Amps CAT II (Qty. 4 ea.)	2001-573
Cable/Spade Lug Adapter (Small): Small lug fits most new relay small terminal blocks. Lug adapter, red, 4.1 mm, use with test leads up to 1000 V/ 20 Amps CAT II (Qty. 15 ea.)	684004
Lug adapter, black, 4.1 mm, use with test leads up to 1000 V / 20 Amps CAT II (Qty. 15 ea.)	684005
Accessory Case, black, used to carry test leads and/or STVI (Qty. 1 ea.)	2001-487

Additional Accessories (Not Included in the SMRT36 Test Leads Option or Deluxe Lead Kit) Additional Optional Test Leads and Accessories can be ordered individually, see description and part numbers below. The following accessories and part numbers are in quantities of 1 each. Order the appropriate number required.	
Individual (Non-Sleeved) Test Leads: Excellent for widely separated individual terminal test connections.	
	
Test Lead, red, use with voltage/current output, or binary I/O, 200 cm long (78.7") 600 V/32 Amps CAT II.	620143
Test Lead, black, use with voltage/current output, or binary I/O, 200 cm long (78.7") 600 V/32 Amps CAT II.	620144

Cable/Spade Lug Adapter (Large): Large spade lug fits older relay terminal blocks, or STATES® Company FTP10 or FTP14 Test paddles, ABB or General Electric test plugs with screw down terminals.	
	
Lug adapter, red, 6.2 mm, use with test leads up to 1000 V/20 Amps CAT II.	684002
Lug adapter, black, 6.2 mm, use with test leads up to 1000 V/20 Amps CAT II.	684003

Description	Part No.
Alligator/Crocodile Clip: Excellent for test connections to terminal screws and pins where spade lugs cannot be used.	
	
Alligator clip, red, use with test leads up to 1000 V/32 Amps CAT III.	684006
Alligator clip, black, use with test leads up to 1000 V/32 Amps CAT III.	684007

Flexible Test Lead Adapter: Use with rail-mounted terminals or screw clamp connections where spade lugs and crocodile/alligator clips cannot be used.	
	
Flexible test lead adapter, black, 1.8 mm male pin, use with test leads up to 1000 V/32 Amps CAT III.	90001-845

Flexible Test Lead Adapter with Retractable Insulated Sleeve: Use for connection to old style non-safety sockets with retractable protective sleeve on one end.	
	
Retractable Sleeve Test Lead, red, 50 cm (20") long, use with test leads up to 600 V, 32 Amperes CAT II.	90001-843
Retractable Sleeve Test Lead, black, 50 cm (20") long, use with test leads up to 600 V, 32 Amperes CAT II.	90001-844

In-Line Fused Test Lead: Use with high speed binary outputs 5 or 6 ("P" Option) to protect for accidental switching of currents higher than 1 Amp.	
	
Test lead, blue, in-line 500 mA fuse protection, 200 cm long (78.7").	568026

In-Line Fused Test Lead: Use with ("P" Option) Battery Simulator output to protect for accidental connection to substation battery.	
	
Test lead, black, in-line 3.15 A fuse protection, 200 cm long (78.7").	568025

In-Line Resistor Test Lead: Use with old solid state relays with "leaky" SCR trip gates.	
	
Test lead, red, in-line 100 k Ohm resistor, use with test leads up to 1000 V/ 32 Amps CAT III.	500395

Description	Part No.
<p>STATES® 10 Pole Test Paddle: Use with STATES FMS Test Switch or ABB FT-1 10 pole Test Switch.</p> 	
<p>Test paddle features knobs which also serve as insulated Ø 4 mm rigid socket accepting spring loaded Ø 4 mm plugs with rigged insulating sleeve, or retractable sleeve. Use with test leads up to 600 V, 32 Amperes CATII.</p>	<p>FTP10</p>

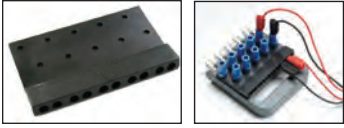
<p>STATES® 10 Pole Test Paddle Attachment: Use with STATES FTP10 Test Paddle.</p> 	
<p>Test paddle attachment provides an additional 10 insulated connection points for front connection, as well as the standard top connections for test leads. Adapter can provide convenient parallel test connections of test currents to two terminals at one time. Use with test leads up to 600 V, 32 Amperes CAT II.</p>	<p>TPA10</p>

Transit Case	
<p>Hard-Sided Transit Case: Includes custom designed foam inserts for the SMRT unit and accessory case. Transit case includes retractable handle, polyurethane wheels with stainless steel bearings, double-throw latches, fold-down handles, and stainless steel hardware and padlock protection, with O-ring seal making the case water-tight, with an IP 67 rating. Tested and certified to US Department of Defense Standards for impact, vibration, and low/high storage temperatures. The case is small, and weighs only 25 pounds (11.25 kg). With a three channel SMRT 36 it is light enough to check as luggage on commercial airliners.</p> 	
<p>Rugged, hard-sided transit case (1ea).</p>	<p>1001-632</p>

Example Configurations	
	
<p>For customers in North America, Central America, Japan, Philippines, South Korea, Taiwan, Thailand, Venezuela, Virgin Islands, and other countries that use standard NEMA type power outlets of 100, 110, 115 or 120 volts at 50/60 Hz. could order a unit with the standard North American power cord. In this example the unit is a SMRT36 three phase unit, with the extra binary I/O and Battery Simulator, with the STV11, without grounded common returns, no Bluetooth, no IEC61850, in the standard enclosure, and with test leads.</p>	<p>The style number would be, SMRT36 – 30P1F0A051</p>
	
<p>For customers in Austria, Belgium, Finland, France, Germany, the Netherlands, Norway, Portugal, Spain, Sweden, Turkey, and other countries where the CEE 7 standard connector is used could order a unit with the Continental European Power Cord with CEE 7/7 Schuko plug. In this example the unit is a 3 phase unit, with the extra binary I/O and Battery Simulator, without the STV11, with floating outputs, no Bluetooth, with IEC61850 enabled, in the standard enclosure, and with test leads.</p>	<p>The style number would be, SMRT36-30P0F0E1S1</p>
<p>The final example is for countries that have more unique power connectors, which will require international color coded wires ready for appropriate male connectors to be installed like; Australia/New Zealand, Argentina, China, Demark, India, South Africa, Ireland, Israel, Russia, Switzerland, or the United Kingdom. These countries are more likely to order the unit with the international color coded power cord ready for mounting the appropriate male connector. In this example the unit is a 3 phase unit, with the extra binary I/O and Battery Simulator, with the STV11, with the floating outputs, with Bluetooth, with IEC61850 enabled, in the standard enclosure, and with test leads.</p>	<p>The style number would be, SMRT36 – 30P1F111S1</p>

SMRT1

Single Phase Relay Test System



- **Small, rugged, lightweight and powerful**
- **Operate with or without a computer**
- **Intuitive manual operation with Smart Touch View Interface**
- **High current, high power (75 Amps/400 VA rms)**
- **Network interface provides IEC 61850 test capabilities**
- **Fully automated testing using AVTS software**

DESCRIPTION

As a stand-alone unit the SMRT1 has the “smart” combination of high compliance voltage and high current to test electromechanical, solid-state and microprocessor-based overcurrent relays, including voltage controlled, voltage restraint and directional overcurrent; test under/over voltage, single-phase impedance, single-phase power, directional, synchronizing, auto-synchronizing, negative sequence under/over voltage, current balance, frequency, volts/hertz, reclosing, thermal, and various other relays, see the Applications Guide for more.

The SMRT1 test system has the ability to be manually controlled with Megger’s new Smart Touch View Interface™ (STVI). The STVI, with its large, full color, high resolution, TFT LCD touch screen allows the user to perform manual, steady-state and dynamic testing quickly and easily using the manual test screen, as well as using built-in preset test routines for most popular relays.

The STVI eliminates the need for a computer when testing virtually all types of relays. Menu screens and touch screen

function buttons are provided to quickly and easily select the desired test function. Tests results can be saved to the PowerDB™ ONBOARD for download to a memory stick to transfer or print test reports. For full automatic testing the SMRT1 may be controlled by Megger Advanced Visual Test Software (AVTS). AVTS is a Microsoft® Windows® XP®/ Vista™/7 compatible software program designed to manage all aspects of protective relay testing using the new Megger SMRT.

APPLICATIONS

The current channel is rated for 30 Amps @ 200 VA continuous, up to 60 Amps @ 300 VA for short durations. It has a unique flat power curve from 4 to 30 Amps that insures maximum compliance voltage to load at all times. With a high compliance voltage of 50 Volts the SMRT1 has the capability to test high impedance overcurrent relays.

The voltage channel can provide a variable output of 0- 30/150/ 300 Volts at 150 VA of output power, and has a unique flat power curve from 30 to 150 Volts insuring maximum output power to the load at all times. With the voltage channel converted to current, it can perform minimum operating point, slope, and timing on current differential relays, including harmonic restraint transformer differential relays (which can be tested one phase at a time).

It is also designed to operate in conjunction with other SMRT family units. Using the Ethernet ports, SMRT1 is literally a “plug-and-play” unit, where voltage and current outputs can be seamlessly synchronized with other SMRT units voltage and current outputs for testing more complex relays like three phase directional power, distance, loss of excitation, or 6, 9 up to 12 phase current test applications.



Model STVI with SMRT1

APPLICATIONS SELECTION GUIDE

Protective Relays by IEEE Device #		SMRT1
2	Time Delay	✓
21	Distance Single Phase	✓
21	Distance Open Delta	+
21	Distance Three Phase wye	++
24	Volts/Hz	✓
25	Synchronizing	+
27/59	Under/Over Voltage	✓
32	Directional Power Single Phase	✓
32	Directional Power Three Phase (Open Delta)	+
37/76	DC Under/Over Voltage/Current	✓
40	Loss of Field	✓
46	Phase Balance Current	✓
46N	Negative Sequence Overcurrent	✓
47	Phase Sequence Voltage (Open Delta)	+
50	Instantaneous Overcurrent	Up to 75 Amps
51	Time Overcurrent	Up to 75 Amps ¹
55	Power Factor	✓
60	Voltage/Current Balance (Open Delta)	+
67	Directional Overcurrent	✓
67N	Ground Directional Overcurrent	✓
78	Out of Step	✓
79	Reclosing	✓
81	Frequency	✓
85	Carrier or Pilot Wire	✓
87	Differential	✓
91	Voltage Directional (Open Delta)	+
92	Voltage and Power Directional (Open Delta)	+
94	Tripping	✓

+ Requires additional SMRT1 for each +

¹ For operating times less than 1.5 seconds. For longer trip times output is rated for 35 Amps continuous with convertible channel in parallel.

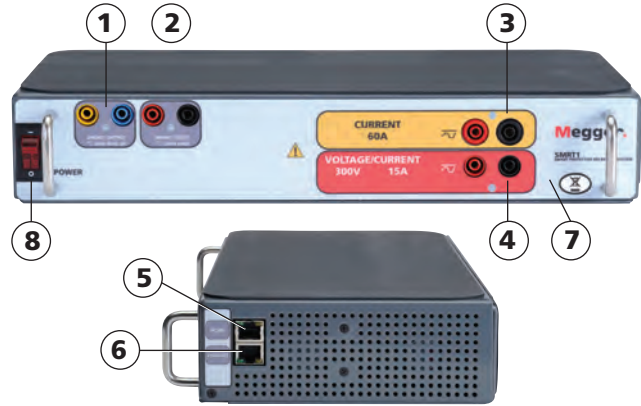

- 1. Binary Output:** Rated for 300 V at 8 Amps.
- 2. Binary Input:** Rated 5 to 300 V AC/DC
- 3. Current Channel:** 0 – 30 Amps at 200 VA continuously, up to 60 Amps at 300 VA for short durations.
- 4. Voltage Channel:** 0 - 300 V at 150 VA, convertible to current rated for 5 Amps at 150 VA continuously, 15 A at 120 VA for short durations.
- 5. PC/IN:** Ethernet Port is the primary PC connection port. This port may also be used for connecting to other SMRT units.
- 6. 61850/OUT:** Ethernet Port may be used to interconnect multiple SMRT units together for synchronous multi-unit operation, or for connecting to the IEC 61850 substation bus.
- 7. Bluetooth:** Bluetooth® provides wireless control.
- 8. POWER ON/OFF:** Switch illuminates when power is on.

FEATURES AND BENEFITS

Constant Power Output – New higher powered Voltage-Current amplifiers. The current amplifier delivers maximum compliance voltage to the load constantly during the test, and range changing is done automatically under load. This insures better test results, and saves time by not having to turn the outputs off to change ranges. Constant power output in many cases eliminates the need to parallel or series current channels together to test high burden relays.

High Output Current – Provides up 30 Amps at 200 VA per phase continuous for timing tests, and can provide up to 60 Amperes at 300 VA for testing instantaneous overcurrent relays.

New PowerV™ Voltage Amplifier High Power Output – The SMRT provides a new higher VA power output on the voltage channel at the lower critical test voltages (from 30 to 150 Volts). Customers who want to test a panel of relays at one time find it impossible using lower VA rated voltage sources.

Convertible Voltage Channel – Provides second current source for testing single phase current differential relays, including harmonic restraint transformer differential relays. Parallel with main current channel to increase output current to 35 Amps continuous, and up to 75 Amps short time.

High resolution and accuracy – Metered outputs provides extremely high accuracy needed for testing a wide variety of devices. Eliminates uncertainty with setting values, with metered values what you see is what you get.

Steady-State and Dynamic testing capability – The SMRT1 provides, either through manual control or computer control, both steady-state and dynamic testing of protective relays. This includes programmable waveforms with harmonics.

Output current and voltage sine waves are generated digitally – Outputs do not vary with sudden changes in input voltage or frequency, which increases test accuracy and reduces testing time.

Digital binary input and output – The programmable binary input, and programmable output provide timing and logic operations in real-time with the output voltage and currents. The Binary Input can be programmed, using Boolean logic, for more complex power system simulations.

Circuit breaker simulator – Binary output provide programmable normally closed or normally open contacts to simulate circuit breaker operation for testing reclosing relays. Sequence of operation, timing, and lockout are easily tested.

Performs transient tests – Perform acceptance or troubleshooting tests by replaying digitally recorded faults or EMTP/ATP simulations in the IEEE- C37.111, COMTRADE Standard format.

Perform End-to-End tests – Using AVTS software and a GPS satellite receiver, the SMRT performs satellite-synchronized end-to-end dynamic multi-state or playback transient COMTRADE files either for commissioning or troubleshooting tests.

Wide-ranging output frequency – The output frequency of the current and voltage outputs can be set for any frequency from dc to 1 kHz. Popular test frequencies such as 16.66, 25, 33, 50, 60, 100,120, 125, 150, 180, 250, 300 and 400 Hz are easily set and controlled. Multi-purpose test system saves time and money.

Two Ethernet ports – PC/IN Ethernet Port is the primary PC connection port. It is also used when chaining multiple SMRT units together. The 61850/OUT Ethernet Port is primarily used to interconnect multiple SMRT units together for synchronous multi-unit operation, or it may be used to connect to the IEC 61850 substation bus.

Universal input voltage – Operation from 90 to 264 VAC, 50/60 Hz, the SMRT can use virtually any standard source in the world.

Immediate error indication – Audible and visual alarms indicate when amplitude or waveforms of the outputs are in error.

BlueTooth – Optional Bluetooth provides more flexibility. A wireless interface between the PC and SMRT, in conjunction with the SMRT IEC 61850 Ethernet port, provides the isolation required for a secure substation access interface between the SMRT and the IEC 61850 substation network.

SPECIFICATIONS¹

Input Power

100 to 240 Volts (± 10%) AC, 1Ø, 50/60 Hz, 700 VA

Outputs

All outputs are independent from sudden changes in line voltage and frequency. This provides stable outputs not affected by sudden changes in the mains source. All outputs are regulated so changes in load impedance do not affect the output.

Output Current

Output power ratings are specified in AC rms values and peak power ratings.

Output Current	Power	Max V / Duty Cycle
1 Ampere	15 VA	15.0 V rms Continuous
4 Amperes	200 VA (282 peak)	50.0 V rms Continuous
15 Amperes	200 VA (282 peak)	13.4 V rms Continuous
30 Amperes	200 VA (282 peak)	6.67 V rms Continuous
60 Amperes	300 VA (424 peak)	5.00 V rms 90 Cycles
DC 200 Watts		

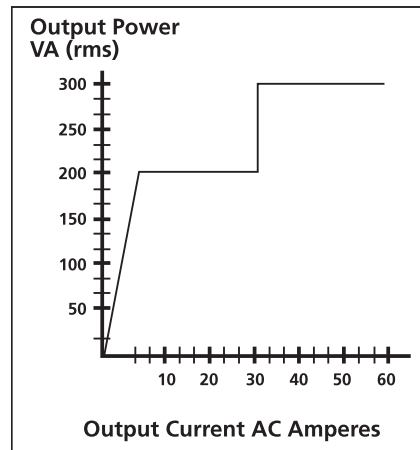

Current Amplifier Output Power Curve

Current Amplifier - Extended Power Range

The SMRT current amplifier provides a unique flat power curve from 4 to 30 Amperes to permit testing of electromechanical high impedance relays, and other high burden applications, with an extended operating range up to 60 Amperes at 300 VA rms.

AC Voltage Output

Outputs are rated with the following Ranges:

Output Volts	Power	Max I
30 Volts	150 VA	5 Amps
150 Volts	150 VA	See "PowerV"
300 Volts	150 VA	0.5 Amps
DC 150 Watts		

Duty Cycle: Continuous

¹ Megger reserves the right to change product specifications at any time.

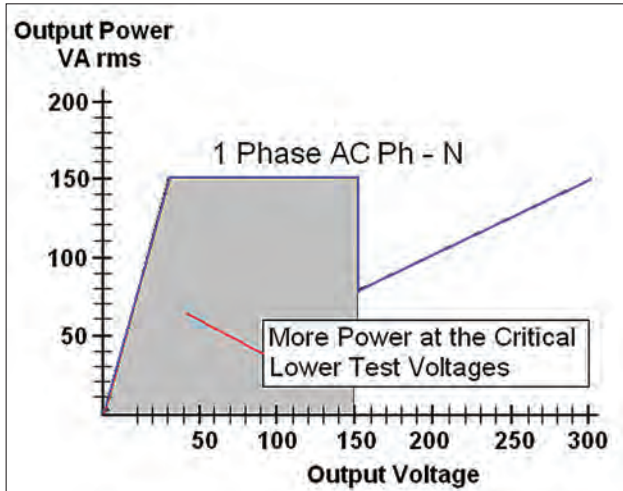

“PowerV” Voltage Amplifier - Extended Power Range

The SMRT voltage amplifier provides a flat power curve from 30 to 150 Volts in the 150V range to permit testing of high current applications such as panel testing.

Voltage Amplifier in Current Mode:

The voltage amplifier is convertible to a second current source with the following output capability. Output power ratings are specified in rms values and peak power ratings.

Output Current	Power	Max V Duty Cycle
5 Amperes	150 VA (212 peak)	30.0 Vrms Continuous
15 Amperes	120 VA	8.0 Vrms 90 Cycles

Phase Angle

Ranges: 0.00 to 359.99 degrees, Counter Clock Wise, or Clock Wise rotation, or 0.00 to ±180.00 degrees
Accuracy: ±0.02° typical, ±0.25° max at 50/60 Hz

Frequency

The output modules provide a variable frequency output with the following ranges and accuracy.

Ranges

DC
 0.001 to 1000.000 Hz
 Output amplifiers can provide transient signals with a range of DC to 10 kHz for transient playback using COMTRADE files.

Resolution*: .0001/.001 Hz

Frequency Accuracy:

2.5 ppm typical
 25 ppm 0° to 50° C, at 50/60 Hz Maximum

Total Harmonic Distortion

Less than 0.1% typical, 2% maximum at 50/60 Hz

Timer

The Timer-Monitor Input is designed to monitor and time-tag inputs, as a sequence of events recorder. In addition, the binary input controls enable the user to perform logic AND/OR functions, and conditionally control the binary output relay to simulate circuit breaker, trip, reclose and carrier control operation in real-time. The Timer function displays in Seconds or Cycles, with the following range and resolution:

Seconds: 0.0001 to 99999.9 (Auto Ranging)

Cycles: 0.01 to 99999.9 (Auto Ranging)

Accuracy: ±0.001% of reading, typical. ±2 least significant digit, ±0.005% of reading from 0 to 50° C maximum

Binary Input – Start/Stop/Monitor Gate

To monitor operation of relay contacts or trip SCR, continuity light is provided for the input gate. Upon sensing continuity the lamp will glow. In addition to serving as wet/dry contacts the Binary Input may be programmed to trigger binary output sequence(s).
Input Rating: up to 300 V AC/DC

Binary Output Relay

SMRT1 has an independent, galvanically isolated, output relay contact to accurately simulate relay or power system inputs to completely test relays removed from the power system. The binary output simulates normally open / normally closed contacts for testing breaker failure schemes. The binary output can be configured to change state based on binary input logic.

AC Rating: 400 V max., **I_{max}:** 8 amps,

2000 VA max. breaking capacity

DC Rating: 300 V max., **I_{max}:** 8 amps, 80 W

Response Time: < 10ms

Waveform Generation

Each output channel can generate a variety of output waveforms such as: DC; sine wave; sine wave with percent harmonics at various phase angles; half waves; square waves with variable duty cycles; exponential decays; periodic transient waveforms from digital fault recorders, relays with waveform recording capability or EMTP/ATP programs, which conform to the IEEE C37.111 COMTRADE standard format.

Metering

Measured output quantities such as AC Amperes, AC Volts, DC Volts or DC Amperes, and Time may be simultaneously displayed on the large, color TFT LCD, optional STVI touch screen. The AC and DC outputs display the approximate voltage/current output prior to initiation of the outputs.

AC Voltage Amplitude

Accuracy: ±0.05% reading + 0.02% range typical, ±0.15% reading + 0.05% range maximum

Resolution: .01

Measurements: AC RMS

Ranges: 30, 150, 300V

AC Current Amplitude

Accuracy: ±0.05% reading + 0.02% range typical, ±0.15% reading + 0.05% range maximum

Resolution: .001/.01

Measurements: AC RMS

Ranges: 30, 60A

DC Voltage Amplitude

Accuracy: 0.1% range typical, 0.25% range maximum

Resolution: .01

Measurements: RMS

Ranges: 30, 150, 300V

DC Current Amplitude

Accuracy: ±0.05 % reading + 0.02 % range typical, ±0.15 % reading + 0.05 % range maximum

Resolution: .001/.01

Measurements: RMS

Ranges: 30A

Convertible Source in AC Current Mode

Accuracy: ±0.05% reading + 0.02% range typical, ±0.15% reading + 0.05% range or ±12.5 mA whichever is greater

Resolution: .001

Measurements: AC RMS

Range: 5, 15A

Temperature Range**Operating:** 32 to 122° F (0 to 50° C)**Storage:** -13 to 158° F (-25 to 70° C)**Relative Humidity:** 5 - 90% RH, Non-condensing**Unit Enclosures**

The SMRT1 unit comes housed in a rugged, metal, lightweight enclosure. IEC Enclosure Rating IP20. Optional enclosure for 19 inch rack mount is available. Rack mount enclosure includes two BNC connectors on the back panel. These connectors are used to amplify an external analog signal using the SMRT amplifiers. Application of ±10 Volts Peak will provide Full Scale output from the selected output.

Dimensions**Standard Enclosure**

13.5W x 2.4H x 6.75D in. (33.75W x 6H x 16.88D cm)

Rack Mount Enclosure

19W x 2.6H x 8.75D in. (47.5W x 6.5H x 21.88D cm)

Weight**Standard Enclosure:** 8.9 lb. (4 kg)**Rack Mount Enclosure:** 10.85 lb. (4.9 kg)**Conformance Standards****Safety:** EN 61010-1**Shock:** MIL-PRF-28800F (30g/11ms half-sine)**Vibration:** MIL-RFP-28800F (5-500Hz, 2.05 g rms)**Transit Drop:** MIL-RFP-28800F

(10 drops, 20 cm, without transit case)

EMC Emissions: EN 61326-2-1, EN 61000-3-2/3,

FCC Subpart B of Part15 Class A

Immunity: EN 61000-4-2/3/4/5/6/8/11**Protection**

Voltage outputs are protected from short circuits and thermally protected against prolonged overloads. Current outputs are protected against open circuits and thermally protected against prolonged overloads.

Communication Interfaces

Ethernet (2)

Bluetooth (optional)

SOFTWARE**AVTS – STVI Basic**

Every unit comes with **AVTS Basic** software and the PC version of the **STVI Basic** software packages. AVTS Basic version includes Online Vector control (for single and multi-state timing tests), Online Ramp control (for automatic ramping of voltage, current, phase angles or frequency) and Online Click-On-Fault (for dynamic tests of impedance relays). Test results may be exported directly to Microsoft Word. AVTS software includes a database for saving test results, which can also provide the necessary information needed for system reliability audits. See **AVTS** bulletin for more information.

The PC version of the STVI software includes the ability to bring all STVI test data (from other STVI units) into file folders for retrieval, review and printing whenever needed. See **STVI** bulletin for more information.

AVTS Advanced

The **AVTS Advanced** version includes all the features in AVTS Basic plus the powerful Test Editor, Dynamic Control (includes dynamic end-to-end testing capability, and waveform recording capability), ASPEN OneLiner™ or Electrocon CAPE™ SS1 File Converter for dynamic testing, and easy to use programming Tools for creating and editing test modules. See **AVTS** bulletin for more information.

AVTS Professional

The **AVTS Professional** version includes all of the features of the Basic and Advanced versions plus some other powerful test tools and features. It includes the DFR Waveform Viewer, One-Touch™ Test, Modbus communication test capability for fully automatic tests, and Waveform Digitizer to digitize scanned waveforms of electromechanical over current time curves. See **AVTS** bulletin for more information.

IEC 61850 GOOSE

The SMRT with the GOOSE enabled, in conjunction with the Megger GOOSE Configurator (MGC) software, can be used in the testing or commissioning of IEC 61850 compliant devices. See **AVTS** bulletin for more information.

ORDERING INFORMATION

STYLE NUMBER IDENTIFICATION

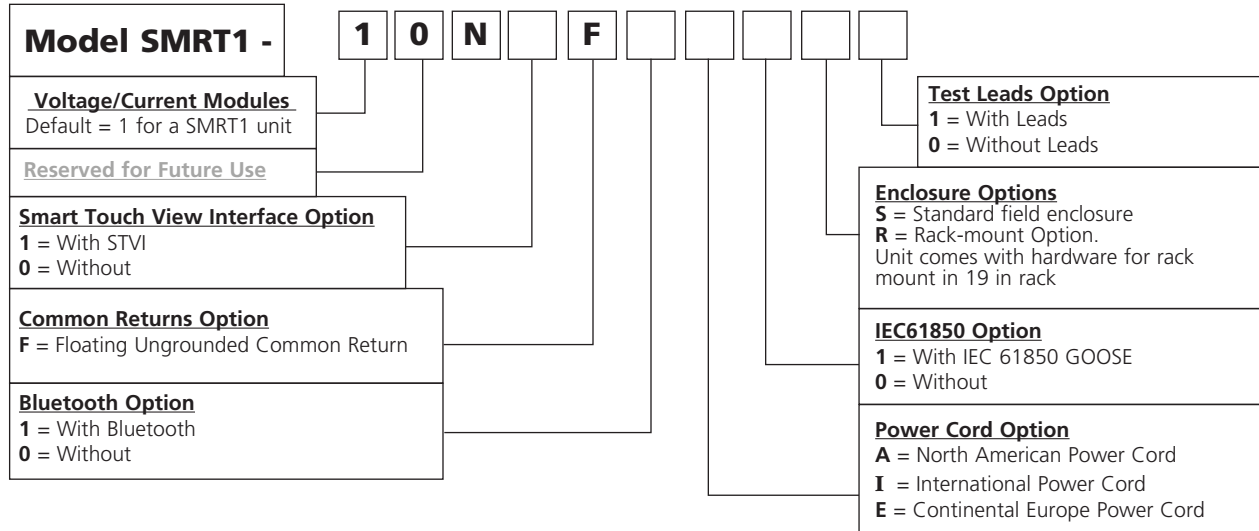

DESCRIPTION OF SOFTWARE OPTIONS

Included Software	Part Number
AVTS Basic with STVI Application CD	81302
AVTS Basic with IEC 61850 Megger GOOSE Configurator, and STVI Application CD	1002-103
Software Options	
AVTS Advanced with STVI Application CD	81570
AVTS Advanced Test with IEC 61850 Megger GOOSE Configurator, and STVI Application CD	1001-106
AVTS Professional with STVI Application CD	81571
AVTS Professional Test with IEC 61850 Megger GOOSE Configurator, and STVI Application CD	1002-102

DESCRIPTIONS OF HARDWARE OPTIONS

Voltage/Current Module: The SMRT1 by default the first digit will always be **1**.
Future: 0, Reserved for future use.
Base Unit Options: SMRT1 does not have any Base Unit options. By default this digit is **N** for None.
Smart Touch View Interface Option: Enter the number **1** for the unit to come with the STVI, or enter the number **0** for without.
Common Returns Option: The SMRT1 unit has only one option, at this time, for the return terminals associated with each output channel. It is **F** for floating returns.
Bluetooth Option: For customers who wish to have a wireless control of the SMRT unit, enter the number **1** for the unit to come with the Bluetooth option installed. Enter **0** for without.
Power Cord Option: Customers can choose which type of power cord they want the unit to come with.

- A Option** – NEMA 5-15 to IEC 60320 C13 connectors, UL & CSA approved for countries with NEMA outlets.

- I Option** - International color coded wires (light blue, brown and green with yellow stripe) insulation jacket stripped ready for male connector with IEC 60320 C13 connector. CE marked.
 - E Option** - CEE 7/7 “Schuko” plug to IEC 60320 C13 connector is CE marked.
- IEC 61850 Option:** The SMRT1 in conjunction with the Megger GOOSE Configurator (MGC) software can be used in the testing or commissioning of IEC 61850 compliant devices. In order for the SMRT1 to be able to subscribe as well as publish GOOSE messages, the IEC 61850 feature needs to be enabled. Enter the number **1** for the unit to come with the IEC 61850 option enabled. Enter **0** for the unit without IEC 61850 enabled.
- Enclosure Option:** The options are **S** for Standard, and **R** for rack mount. Enter **S**, for Standard, rugged metal field type enclosure. The rack unit will come in a metal enclosure with 19 inch rack mount hardware installed.
- Test Leads Option:** Enter the number **1** for the unit to come with Test Leads. Enter **0** for the unit without Test Leads.

DESCRIPTION

Included Standard Accessories	Part Number
Power Cord - Depending on the style number, the unit will come with one of the following,	
Line cord, North American	620000
Line cord, Continental Europe with CEE 7/7 Schuko Plug	50425
Line cord, International color coded wire	15065
Ethernet crossover cable for interconnection to PC, 210cm (7 ft.) long (Qty. 1 ea)	620094
Instruction manual CD	80989

Table of Accessories

Accessories are supplied with the selection of the Test Leads Option and/or the STVI Option. If desired, Test Leads and Accessories can be ordered individually, see description and part numbers below.

	Optional Accessories Descriptions	STVI and/or Test Leads Option	Test Leads Option
	Accessory Carry Case: Use to carry power cord, Ethernet cable, Optional STVI and test leads.	Qty. 1 ea. Part No. 2001-487	
	Sleeved Pair of Test Leads: Keeps the test leads in pairs and from getting entangled. Sleeved Test Leads, one red, one black, 200 cm (78.7") long, 600 V, 32 Amperes CAT II		Qty. 4 pr. Part No. 2001-394
	Cable/Spade Lug Adapter (Small): Small lug fit most new relay small terminal blocks. Lug adapter, red, 4.1 mm, use with test leads up to 1000 V/ 20 Amps CAT II		Qty. 4 ea. Part No. 684004
	Lug adapter, black, 4.1 mm, use with test leads up to 1000 V/ 20 Amps CAT II		Qty. 4 ea. Part Number 684005
	Jumper Lead: Used to common returns together on units with floating ground returns, or parallel of current channels. Jumper lead, black, 12.5 cm (5") long, use with voltage / current outputs, 600 V, 32 Amps CAT II		Qty. 1 ea. Part Number 2001-573

Descriptions of Software

Included Software – Every unit comes with AVTS Basic and the PC version of the STVI Basic Test software packages

AVTS Basic with STVI Application Software (PC Version) Part No.: 81302

AVTS Basic includes Online Vector, Online Ramp and Online Click-On-Fault controls, with the ability to import, save and execute relay specific test modules. The online tools of Vector and Ramp provide automatic pickup, or dropout tests as well as timing and multi-state dynamic tests. The Online Click-On-Fault tool is used to automatically determine the reach characteristics of single or multi-zone Distance relays using shot for single point tests, or Ramp, Pulse Ramp, or Binary Search tools along user defined search lines. Includes enhanced Relay Test Wizards for; Overcurrent, Differential, Voltage, Frequency and Distance relays.

The powerful STVI screens can be run directly from a PC providing both manual and automatic test capabilities. Intuitive menu screens and buttons are provided to quickly and easily select the desired test function. The Manual Test Screen power-up preset default values maybe automatically set from the user defined configuration screen. The user can select from a variety of test options including manual control using the cursor up down arrows or use the mouse

control wheel to vary outputs. In addition a dynamic sequence test includes trip and reclose up to 9 operations. An automatic ramp, pulse ramp, binary search or pulse ramp binary search is built in to determine pickup or drop out of relay contacts, or perform relay specific timing tests using the Timing Test Screen. A vector graph indicates the relative phase angles of all of the outputs. The user may select to have all output amplitudes metered to provide real time verification of all of the selected outputs, or have setting values displayed. The PC version of the STVI software includes the ability to bring all STVI test data (from other STVI units) into file folders for retrieval and review whenever needed. Each copy of the PC version of the STVI software is licensed for running on one PC. Additional run keys can be purchased separately.

Additional Software Options

AVTS Advanced with STVI Application Part No.: 81570

AVTS Advanced includes all of the features of AVTS Basic in addition to the powerful Test Editor and test editor tools, which includes the Dynamic Control (with dynamic end-to-end test capability, and Recorder features) for developing sequential tests for virtually any function or measuring element within digital relays. In addition, it also includes SS1 File Converter for ASPEN and CAPE dynamic test files, End-to-End DFR Playback test macros and basic programming Tools for creating and editing test modules. Test files created in Advanced Test can be used with AVTS Basic.

AVTS Professional with STVI Application Part No.: 81571

Professional Test includes all of the features of AVTS Advanced Test version plus the following additional specialized test tools. The DFR Waveform Viewer and Playback tools are used for viewing and analyzing IEEE C37.111 COMTRADE Standard files from digital fault recorders and microprocessor based relays. The DFR Waveform Viewer includes tools to recreate the analog and digital channels for playback into protective relays for troubleshooting or evaluation. It includes the capability to extend the pre-fault data as well as start the timer associated with the event to time relay operation. These playback test files can also be used in end-to-end tests to recreate the transient event and evaluate the protection scheme. Test files created in Professional can be used with Advanced Test and Basic. Also included is the One-Touch Test Editor Control Tool for fully automatic testing of microprocessor based relays using VB script files or Modbus communications for automatic download of settings, to automatically download relay settings, and automatically test all the measuring elements within the relay based upon those settings. The Waveform Digitizer feature is also included in the Professional Test version of AVTS. It provides tools to create digital time curves for virtually any electromechanical relay time curve (that do not fit a time curve algorithm). It can even be used for digitizing scanned waveforms from a light-beam chart recorder.





IEC 61850 Megger GOOSE Configurator Software

The Megger GOOSE Configurator (MGC) provides easy to use tools for testing relays and substations using the IEC 61850 protocol. It is an optional software tool available with Basic, Advanced or Professional versions of AVTS Software; see Descriptions of Software Options above. The configurator provides relay test engineers and technicians the capability to import parameters from configuration files in the Substation Configuration Language (SCL) format, and/or capture GOOSE messages directly from the substation bus. All imported GOOSE messages will be unconfirmed messages. Only captured messages are confirmed messages due to the Capture feature of the MGC. Use the MGC Merge feature to compare imported SCL and captured GOOSE messages to verify all GOOSE messages needed to perform tests. Use them to configure the SMRT to subscribe to preselected GOOSE messages by assigning the data attributes to the appropriate binary inputs of the SMRT. Use the configurator to assign the appropriate binary

outputs of the SMRT to publish GOOSE messages simulating circuit breaker status. After the appropriate assignments of binary inputs and outputs have been made, the test file can be saved for reuse. This provides both manual and automatic testing of the relay using either the STVI or AVTS software. Use standard test modules in AVTS to perform automatic tests. Use the Dynamic Control in AVTS Advanced or Professional to perform high speed trip and reclose tests, or use to perform interoperability high-speed shared I/O tests between multiple IED's. The MGC provides mappings of Boolean and Bit Strings and/or simulation of STRuct, Integer/Unsigned, Float and UTC datasets.

**Additional Accessories
(Not Included in the SMRT1 Test Leads Option)**

Additional Optional Test Leads and Accessories can be ordered individually, see description and part numbers below. The following accessories and part numbers are in quantities of 1 each. Order the appropriate number required.

Description	Part No.
Individual (Non-Sleeved) Test Leads: Excellent for widely separated individual terminal test connections.	
	
Test Lead, red, use with voltage/current output, or binary I/O, 200 cm long (78.7") 600 V/32 Amps CAT II.	620143
Test Lead, black, use with voltage/current output, or binary I/O, 200 cm long (78.7") 600 V/32 Amps CAT II.	620144
Cable/Spade Lug Adapter (Large): Large spade lug fits older relay terminal blocks, or STATES® Company FTP10 or FTP14 Test paddles, ABB or General Electric test plugs with screw down terminals.	
	
Lug adapter, red, 6.2 mm, use with test leads up to 1000 V/20 Amps CAT II.	684002
Lug adapter, black, 6.2 mm, use with test leads up to 1000 V/20 Amps CAT II.	684003
Alligator/Crocodile Clip: Excellent for test connections to terminal screws and pins where spade lugs cannot be used.	
	
Alligator clip, red, use with test leads up to 1000 V/32 Amps CAT III.	684006
Alligator clip, black, use with test leads up to 1000 V/32 Amps CAT III.	684007
Flexible Test Lead Adapter: Use with rail-mounted terminals or screw clamp connections where spade lugs and crocodile/alligator clips cannot be used.	
	
Flexible test lead adapter, black, 1.8 mm male pin, use with test leads up to 1000 V/32 Amps CAT III.	90001-845

Description	Part No.
Flexible Test Lead Adapter with Retractable Insulated Sleeve: Use for connection to old style non-safety sockets with retractable protective sleeve on one end.	
	
Retractable Sleeve Test Lead, red, 50 cm (20") long, use with test leads up to 600 V, 32 Amperes CAT II.	90001-843
Retractable Sleeve Test Lead, black, 50 cm (20") long, use with test leads up to 600 V, 32 Amperes CAT II.	90001-844

In-Line Fused Test Lead: Use with high speed binary outputs 5 or 6 ("P" Option) to protect for accidental switching of currents higher than 1 Amp.	
	
Test lead, blue, in-line 500 mA fuse protection, 200 cm long (78.7").	568026

In-Line Fused Test Lead: Use with ("P" Option) Battery Simulator output to protect for accidental connection to substation battery.	
	
Test lead, black, in-line 3.15 A fuse protection, 200 cm long (78.7").	568025

In-Line Resistor Test Lead: Use with old solid state relays with "leaky" SCR trip gates.	
	
Test lead, red, in-line 100 k Ohm resistor, use with test leads up to 1000 V/ 32 Amps CAT III.	500395

STATES® 10 Pole Test Paddle: Use with STATES FMS Test Switch or ABB FT-1 10 pole Test Switch.	
	
Test paddle features knobs which also serve as insulated Ø 4 mm rigid socket accepting spring loaded Ø 4 mm plugs with rigged insulating sleeve, or retractable sleeve. Use with test leads up to 600 V, 32 Amperes CATII.	FTP10

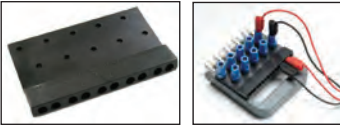
STATES® 10 Pole Test Paddle Attachment: Use with STATES FTP10 Test Paddle.	
	
Test paddle attachment provides an additional 10 insulated connection points for front connection, as well as the standard top connections for test leads. Adapter can provide convenient parallel test connections of test currents to two terminals at one time. Use with test leads up to 600 V, 32 Amperes CAT II.	TPA10

STVI

Smart Touch View Interface

Handheld Controller for SMRT and MPRT Test Sets

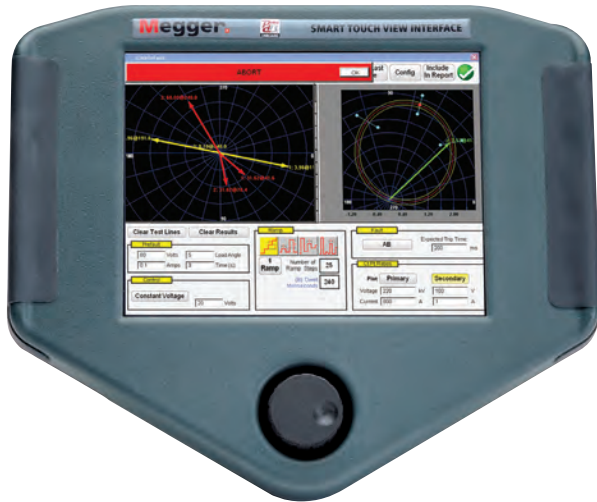

- Large High Resolution Color TFT LCD touch-screen intuitive smart navigation makes testing relays easier
- Designed for either right or left handed operation with control knob centrally located
- Automatic Ramp, Pulse Ramp, and Pulse Ramp Binary Search Capability for pick up and dropout tests
- Overcurrent Relay Test includes IEC, IEEE and hundreds of Specific Relay Time-Curves Built-in
- Dynamic Testing Capability, Multi-Shot Trip and Reclose “Sequencing” test screen
- Save/View/Print results from internal PowerDB ONBOARD
- Download results via USB to print

DESCRIPTION

The Smart Touch View Interface™ (STVI) is Megger’s second generation of handheld controllers for the new SMRT and older MPRT¹ relay test systems. The STVI, with its large, full color, new high resolution, and high definition TFT LCD touch screen allows the user to perform manual, steady-state and dynamic testing quickly and easily using the Manual or Sequencer test screens, as well as using built-in preset test routines for most popular relays.

Ergonomically designed for either right or left hand operation using the rubber cushion grips, the centrally located control knob, and the touch screen, the STVI is extremely easy to use. Use the new built-in stand for single-handed operation. The STVI uses a standard Ethernet cable, and Power Over Ethernet (POE) operation. The STVI includes non-volatile built-in data storage for saving tests and test results. A USB port is provided for transferring test results to your PC.

APPLICATION

The most significant feature of the STVI is its ability to provide the user with a very simple way to manually test, for both commissioning and maintenance, from the simple overcurrent relay to the most complex relays manufactured today. Manual operation is simplified through the use of a built-in computer operating system and the touch screen. The STVI eliminates the need for a computer when testing virtually all types of relays. Intuitive menu screens and touch screen buttons are provided to quickly and easily select the desired test function.

Here’s how easy it is

Manual Test Screen

In the following Manual Test screen the pre-selected outputs are set using the touch screen, or power-up preset default values maybe automatically set from the user defined configuration screen. The user can select from a variety of test options including manual control using the control dial, a dynamic sequence of tests to include trip and reclose operations, an automatic ramp, pulse ramp, or pulse ramp binary search to determine pickup or drop out of relay contacts, or perform relay specific timing tests. By pressing the ON  button, the selected output indicators will change colors indicating which outputs are energized.

	V	VOLTAGE		Hz	A	CURRENT	
		V	Deg			A	Deg
1	69.00	0.00	60.000	1.000	30.00	60.000	
2	69.00	120.00	60.000	1.000	150.00	60.000	
3	69.00	240.00	60.000	1.000	270.00	60.000	

Figure 1. STVI Manual Test Screen

¹ Requires external power supply adapter

A vector graph indicates the relative phase angles of all of the outputs. The user may select to have all output amplitudes metered to provide real time verification of all of the selected outputs, or have setting values displayed.

In the Manual test screen the user can set Prefault and Fault values. The user can toggle back and forth between the two values to monitor contact activity. To do a simple timing test the user can set Prefault time duration in seconds, and then press the Blue Play button. The Prefault values will be applied for the Prefault time, then change to the Fault values and start the Timer running. When the relay trips, it will stop the timer, and may turn selected outputs off depending on the user defined Auto-Off configuration.

Auto Ramp, Pulse Ramp and Binary Search Features

The STVI may be used to determine pickup or dropout of various types of relays. Pressing the Auto Ramp button  presents three choices; Step Ramp, Pulse Ramp,



Figure 2. Ramp and Search Tool Bar

and Pulse Ramp Binary Search. The first selection, Step Ramp, will ramp the output by applying a value and then waiting a specific amount of time before incrementing. For example, to automatically ramp output current the user will select the channel to be ramped, input Start and Stop Amplitudes, an Increment (A), and a Delay time in Cycles (B). See the following figure.

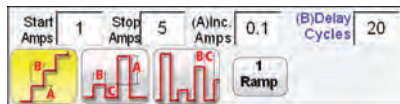

Figure 3. Ramp Setting Example

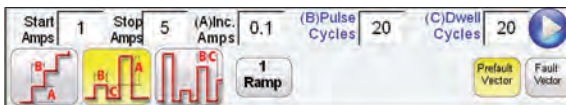



Figure 4. Pulse Ramp Setting Example

Pulse Ramp will start at user defined prefault condition, increment up or down returning to the prefault condition between each increment. Instead of Delay time the user sets the Pulse Cycles time, which applies the fault value to the relay for the specified time. The user can select a 2nd, 3rd and 4th ramp if desired, changing the size of the increment with each ramp. This feature is most used when doing instantaneous pickup tests. The output current, or voltage, can be incremented in large steps getting to

the pickup point quickly, and then reduce the size of the increment to zero-in on the pickup value. This reduces the test time, heating of the relay under test, and provides a very accurate test result. This feature is also used when testing multi zone distance relays using three phase voltage and currents. Set the Pulse Cycles duration just long enough for the intended zone to operate. If you are not sure exactly where the pickup value of the relay is, you can use the Pulse Ramp Binary Search feature.

Timing Test Feature

Pressing the Time test button  on the top menu bar, the user is presented a menu of relays to test. Built-in timing tests are provided for a wide variety of protective relays, including Overcurrent, Voltage, and Frequency relays. To make it even easier and faster, the STVI has IEEE and IEC standard time curve algorithms built-in. In addition, the STVI also includes time curves and time curve algorithms for hundreds of different specific relays selectable by manufacturer, model number, and curve shape (inverse, very inverse, definite time etc.). In the following example, the G.E. IAC-51 relay with a 1 Amp Tap and a number 2 Time Dial was selected.

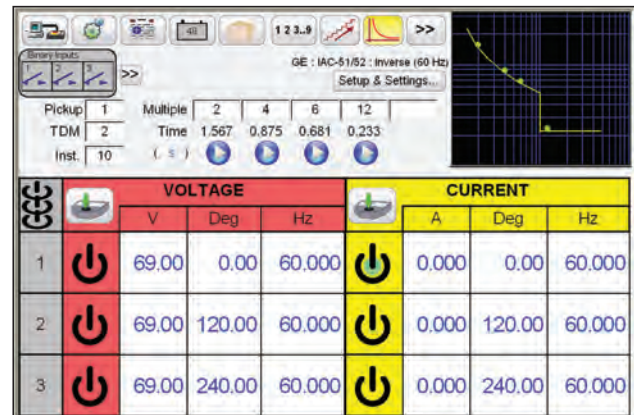



Figure 5. Timing Test Screen for G.E. IAC-51 Inverse Overcurrent Relay

By entering the appropriate values in the setting screen, when the timing test is conducted, the test results will automatically be plotted and compared to the theoretical values from the relay specific time curve that was selected. If the test Multiple is changed, the appropriate theoretical trip time will change automatically.

View Test Reports

To View the test result, press the Add to Reports  button. The user can now enter appropriate information relative to the test in the Test Report header. See the following example report.

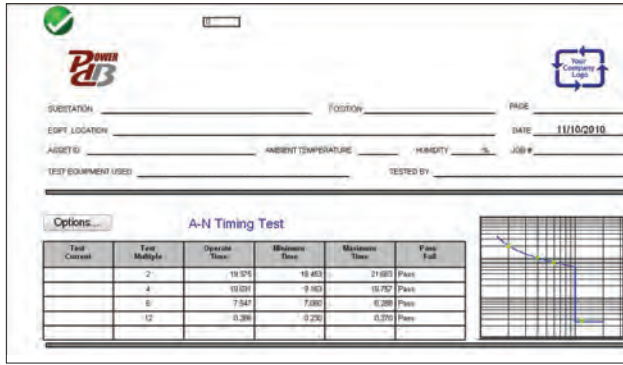

Figure 6. Test Report Alstom IEC Inverse Timing Test

Note that the software automatically compared the Operating Time to the theoretical and made a Pass/Fail determination based upon the manufacturer's time curve characteristic. If the recorded test point(s) is out of specification it appears red in color. If it is within specification it will be green in color. This provides excellent visual As Found reporting. Up to 5 points maybe plotted including Instantaneous trip points. If the data is imported into PowerDB reports can be generated that summarize the comments and failures of every test you perform.

State Sequence Timing Test Feature

Pressing the State Sequence button **1 2 3..9** on the top menu bar takes the user to the Sequence Timing Test Screen. There are 9 programmable steps available in the Sequence Test Screen.

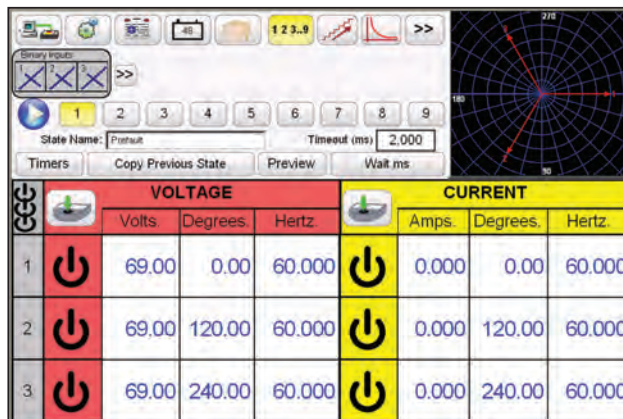

Figure 7. Sequence Test Screen

By default, the 9 states are already labeled as Prefault, Trip1, Reclose 1, etc. up to Lockout in step 9. Therefore, it is initially setup for a four shot trip, reclose to lockout scenario. The user is free to change the labels, or use the default labels. With each state the user may input values of voltage, current, phase angle, frequency and set the Binary Input sensing for each state. Both single pole and three pole trip can be simulated. There are default values and binary settings for a single phase trip and reclose scenario already programmed in. The user can either use the defaults or change them to suit the application. Press the Timers button to view the Timer Settings and Labels.

In addition the user can view where each timer starts and stops in association with each trip and reclose operation (see the following figure).

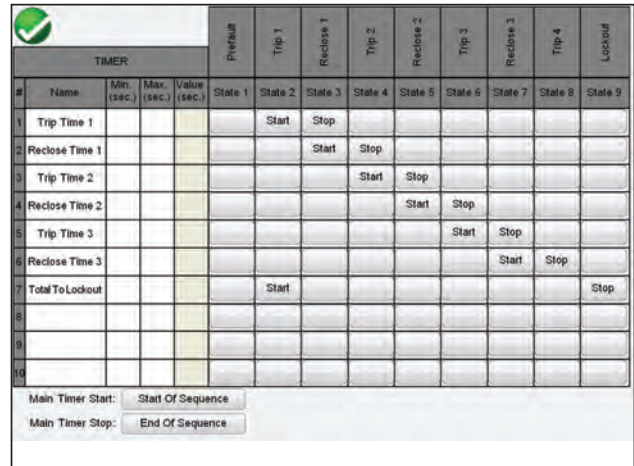

Figure 8. Sequence Timers Settings and Labels Screen

Note that the Total Time to Lockout is also included in the setting and indicates where the total timer starts and stops. This allows for 1, 2, 3, or 4 shots to lockout including reclose times. To set the conditions for each change of state press the Wait button directly under the Timeout window. The user will be presented with several conditional settings to choose from, such as wait milliseconds, wait cycles, wait any contact (OR), and wait all contacts (AND). These are some of the conditions that the unit will take in order to determine when to change to the next state.

To set the Binary Outputs to simulate the 52a and/or 52b contacts press the smaller **>>** "more" button next to the Binary Inputs block to expand the selection window. Press on Show All Binary Outputs, and all the appropriate number of Binary Outputs, along with a select number of Binary Inputs will be displayed. In the prefault state you may choose to have Binary Output 1 contact in the closed condition to simulate breaker closed. Click on Binary Output 1 and the Binary Output setting window will appear. The default setting is Open. Click on the Close Contact Button to simulate breaker closed. Note the Name in the window is defaulted to 1. The user is free to rename it to any name or value (that will fit in the allotted space) by touching the window and use the virtual keyboard.

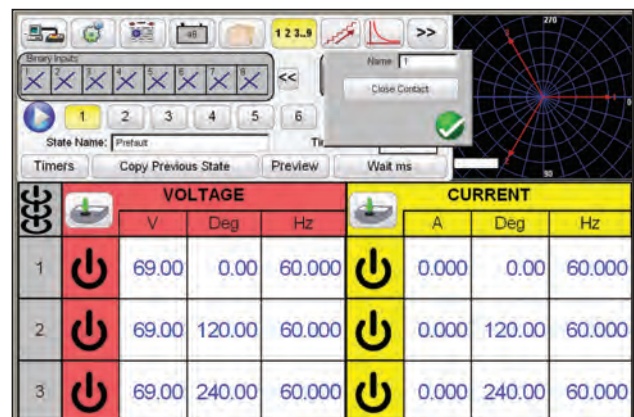

Figure 9. Binary Output Setting Screen

Once all of the Binary Inputs, Outputs, Prefault, Fault and Reclose settings are completed, the user can then press the Preview button to get a visual representation of the voltage and current outputs, as well as a visual of the binary inputs and outputs for each stage of the simulation. The following figure illustrates a sample sequence.

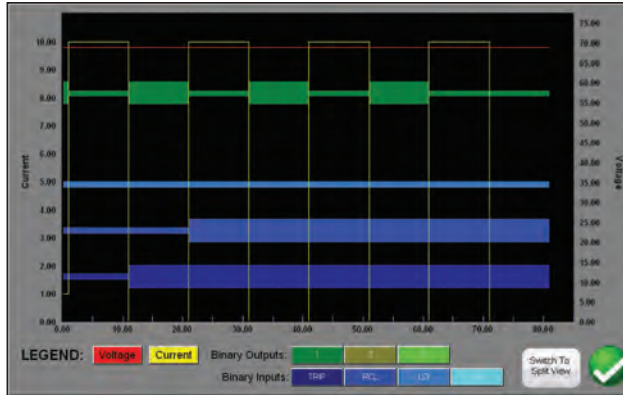

Figure 10. State Sequence Preview Screen

Press the Preview button again to return to the State Sequence Test Screen. To execute the test press the Blue play button. Save and review test results as previously discussed.

Adding New Features

The STVI has many powerful test features. However, there are many new features that are still to come. Megger is continuously developing new products and improving existing products. Once a new feature completes certification tests, it may be downloaded into the STVI as a field upgrade. One of the new features for the STVI that is undergoing certification tests is Click-on-Fault (CoF) for testing impedance relays.

FEATURES AND BENEFITS

Large Color TFT LCD touch-screen display – The STVI features an easy to read high resolution display providing manual control of the test set, and displays measured values of voltage, current, along with phase angle and frequency even in direct sunlight. Color contrasts accentuate vital information. This reduces human error and saves time in testing relays.

Use with SMRT and MPRT relay test sets – Operates the new SMRT as well as the older MPRT relay test sets. Universal application provides flexibility of use.

Easy to use for manual tests – The STVI touch screen is intuitive to use, and requires no special training. Touch screen function buttons, with powerful testing tools such as auto ramp, binary search, pulse ramp binary search, or the simple to use control knob may be used to determine pickup or drop out of relay contacts.

Internal memory – The STVI provides storage of test set-up screens and test results, which reduces testing time and paper work. Saved test results can be downloaded into the PowerDB ONBOARD software for report generation using the built-in USB port.

Steady-State and Dynamic test capability – The STVI in conjunction with either the SMRT or older MPRT provides both steady-state and dynamic testing of protective relays. Set prefault, fault and simulate circuit breaker operation using the STVI sequence test screen. Perform trip and reclose timing tests with up to 9 operations including lockout. Save trip, reclose times to the internal memory and print out later. The STVI provides complex timing tests without the need of a PC.

Display screen prompts operator – The STVI features a touch screen that prompts the user with easy to use function buttons. Single button operation and intuitive ease of use saves time in testing relays and minimizes human error.

Display screen provides four languages – The STVI display screen currently prompts the user in English, French, German, and Spanish.

Immediate error indication – Audible and visual alarms indicate when amplitude or waveforms of the outputs are in error, such as shorting a voltage channel.

STVI Specification

Input Power:

The STVI draws power through the Ethernet cable using Power-Over-Ethernet (POE) from the host unit (SMRT36), or from an external Power Over Ethernet power supply and Ethernet interface for use with SMRT1 or MPRT units.

Communication Interfaces:

Ethernet RJ45, 10/100 Mbits/s

USB Ports: 2

Power over Ethernet

IEEE Std 802.3 AF

Display Screen

The TFT LCD display provides high resolution, and features Wide Viewing Angle Technology and a large screen with high luminance for reading in direct sunlight.

Dimensions: 5.13 H X 6.84 W in (128.2 H X 170.9 W mm), 8.4" Diagonal

Display: 262k Colors, backlit, TFT LCD touch screen, Anti-glare surface with hard coating, 800 Cd/m² Luminance, 640 x 480 pixels

Languages: English, French, Spanish and German.

Temperature Range

Operating: 32 to 122° F (0 to 50° C)

Storage: -13 to 158° F (-25 to 70° C)

Relative Humidity: 5 - 90% RH, Non-condensing

Unit Enclosure

The STVI unit comes housed in a rugged, lightweight and ergonomic plastic enclosure. It features large rubber handles, and a built in stand for hands-off operation.

Dimensions

11 W x 9.375 H x 1.875 D in. (275 W x 234 H x 46.8 D mm)

IEC Enclosure Rating:

IP30

Weight

3.6 lb. (1.6 kg)

CONFORMANCE STANDARDS

Safety

EN 61010-1

Shock, Vibration and Transit Drop

Shock: MIL-PRF-28800F (30g/11ms half-sine)

Vibration: MIL-RFP-28800F (5-500Hz, 2.05 g rms)

Transit Drop Test: MIL-PRF-28800F (46cm, 10 impacts)

Electromagnetic Compatibility

Emissions: EN 61326-2-1, EN 61000-3-2/3,

FCC Subpart B of Part 15 Class A

Immunity: EN 61000-4-2/3/4/5/6/8/11

ORDERING INFORMATION

Item (Qty)	Cat. No.
Smart Touch View Interface for SMRT36 relay test system (1 ea)	STVI-1
Smart Touch View Interface for SMRT1 or MPRT relay test system (1 ea)	STVI-2
Included Accessories with STVI-1	
Quick Start Guide (1 ea)	81358
STVI Application Software CD	81302
STVI Ethernet Cable Assy., 210 cm (7ft.) long, (1 ea)	620094
Included Accessories with STVI-2	
Quick Start Guide (1 ea)	81358
STVI Ethernet Cable Assy., 210 cm (7ft.) long, (1 ea)	620094
Power Over Ethernet Power Supply for SMRT1 or MPRT (1 ea)	90001-736

ISO STATEMENT

Registered to ISO 9001:1994 Reg no. Q 09250

Registered to ISO 14001 Reg no. EMS 61597

STVI_DS_en_N